

# HFE1600 SERIES INSTRUCTION MANUAL

<b>CHAPTER 1:</b>	<b>HFE1600 SERIES SPECIFICATIONS.....</b>	<b>1</b>
	1.1 HFE1600 rated output Current and Voltage versus Line Voltage.....	3
	1.2 HFE1600 Output Power vs. Temp derating.....	4
	1.3 HFE1600 Outline Drawing.....	5
	1.4 Rear Panel IN/OUT Connector Pins Function Description.....	6
<b>CHAPTER 2:</b>	<b>SAFETY APPROVALS .....</b>	<b>7</b>
	2.1 Safety Instructions.....	7
<b>CHAPTER 3:</b>	<b>SINGLE UNIT OPERATION .....</b>	<b>10</b>
	3.1 Front Panel Indicators.....	10
	3.2 Single unit operation.....	11
	3.2.1 Basic configuration (Local Sense).....	11
	3.2.2 Basic configuration (Remote Sense).....	11
	3.2.3 ON/OFF Control by Enable.....	12
	3.2.4 ON/OFF Control by INHIBIT.....	12
	3.2.5 Output Voltage Programming by External Voltage.....	12
	3.2.6 Output Voltage Programming by External Potentiometer.....	13
	3.2.7 SUPERVISORY Signals (Typical Connection).....	13
<b>CHAPTER 4:</b>	<b>POWER SUPPLIES CONNECTION .....</b>	<b>14</b>
	4.1 Parallel Operation.....	14
	4.2 Series Operation.....	15

**CHAPTER 1: HFE1600 SERIES SPECIFICATIONS**

HFE1600 SERIES SPECIFICATIONS:			HFE1600-12	HFE1600-24	HFE1600-32	HFE1600-48	
1	Rated output voltage	V	12	24	32	48	
2	Output voltage set point	V	12+/-1%	24+/-1%	32+/-1%	48+/-1%	
3	Output voltage range	V	9.6~13.2	19.2~29.0	25.6~38.4	38.4~58	
4	Rated Output Current at Vin ≥ 170Vac (*1)	A	133	67	47	33	
5	Rated Output Current at 100 ≤ Vin ≤ 132Vac (*1)	A	100	50	37.5	25	
6	Rated Output Current at 85V ≤ Vin < 100Vac (*1)	A	Linear derating 1% per 1Vac from output current at 100Vac.				
7	Rated output power Vin ≥ 170Vac	W	1596	1608	1504	1584	
8	Rated output power 100 ≤ Vin ≤ 132Vac	W	1200	1200	1200	1200	
9	Rated output power 85Vac ≤ Vin < 100Vac	W	Linear derating 1% per 1Vac from output power at 100Vac.				
10	Input voltage / frequency range (*2)	---	85~265Vac continuous, 47~63Hz, Single phase.				
11	Maximum input current (at 115/230Vac)	A	12.4/8.1.				
12	Power Factor (Typ.) (at 115/230Vac)	---	>0.99/0.98 at maximum output power.				
13	Efficiency at 75% rated load (Typ.) (*3)	%	87/90	88/90	88/90	89/92	
14	Efficiency at 100% rated load (Typ.) (*3)	%	87/90	87/90	87/90	88/91	
15	Inrush current (*4)	A	Less than 35.				
16	Hold-up time	mS	≥ 10mS typical at 115/230Vac input, rated output voltage and less than 80% of rated load.				
17	Maximum line regulation (*5)	%	0.25				
18	Max load regulation (*6)	%	0.50				
19	Output Ripple and noise P-P (*7)	0~+70°C	mV	240	240	320	480
		-10~0°C	mV	360	360	580	780
20	Temperature stability	---	0.05% of rated Vout for 8hrs after 30min warm-up. Constant line, load and temp.				
21	Temperature coefficient of output voltage	PPM/°C	+/-200.				
22	Remote sensing (*8)	---	Possible. Refer to Instruction Manual.				
23	Parallel operation (*9)	---	Possible. Single wire current share, 5% accuracy of rated lout, up to 10 units of the same voltage rating.				
24	Series operation	---	Possible (with external diodes), 2 units. Refer to Instruction Manual.				
25	Over current protection	85V ≤ Vin < 132Vac	---	Minimum 105% of rated output current.			
		170V ≤ Vin < 265Vac	---	105~120% of rated output current.			
26	Over voltage protection (*10)	V	Tracking OVP, range: 1.1xVout, accuracy: +/-3%, refer to Instruction Manual.				
27	Over temperature protection	---	Inverter shut down method, automatic recovery.				
28	Remote On/Off control	---	Two complementary inputs. By electrical signal or dry contact. Refer to Instruction Manual.				
29	"DC OK" signal (*13)	---	Tracking, On when Vout>90+/-5% of output voltage setting.				
30	Over-Temperature warning (*13)	---	Refer to Instruction Manual.				
31	"AC FAIL" signal (*13)	---	On when 85Vac<Vin<270Vac.				
32	Auxiliary power supply output (*11)	---	11.2~12.5V, 0.5A. 240mVp-p noise maximum.				
33	Vout programming by external voltage	---	By 0~5V, equal to Vout min ~ Vout max. Refer to Instruction Manual.				
34	Vout programming by external resistor	---	By 1Kohm potentiometer. Refer to Instruction Manual.				
35	Front panel indicators	---	AC OK, DC OK/FAIL.				
36	I <sup>2</sup> C Interface	---	Not available.				
37	Operating temperature (*15)	---	-10~+50°C: 100% load. +50°C to +60°C Derate 2%/°C of load. +60°C to +70°C Derate 2.5%/°C of load.				
38	Storage temperature	---	-30~85°C.				
39	Operating humidity	---	10~90% RH, no condensation.				
40	Storage humidity	---	10~95% RH, no condensation.				
41	Cooling	---	By internal Fans. Variable speed control based on ambient temp and power level.				
42	Vibration	---	Built to meet IEC60068-2-64 (Basic Transportation).				
43	Shock	---	Built to meet IEC60068-2-27 (Basic Transportation).				
44	Conducted emission (*14)	---	Built to meet EN55032 Class B, FCC part 15 Class-B, VCCI Class-B.				
45	Radiated emission (*14)	---	Built to meet EN55032 Class A, FCC part 15 Class-A, VCCI Class-A.				
46	Immunity	---	Built to meet IEC61000-4-2 (Level 2,3), -3 (Level 2), -4 (Level 2), -5 (Level 3,4), -6 (Level 2), -8 (Level 4), -11				
47	Applicable safety standards	---	UL60950-1, EN60950-1.				
48	Withstand voltage	Input-Output:	---	3000Vrms, 1min.			
		Input-Ground:	---	2000Vrms, 1min.			
		Output - Ground:	---	500Vrms, 1min.	500Vrms, 1min.	500Vrms, 1min.	2250Vdc, 1min.
49	Insulation resistance	---	More than 100Mohm at 25°C and 70% RH. Output-Ground: 500Vdc.				
50	Leakage current (*12)	mA	Less Than 0.75/1.5 at 115/230Vac range.				
51	Weight (Typ.)	Kg	Max. 1.55.				
52	Size (W*H*D)	---	85x41x300mm. Refer to Outline Drawing.				

**Notes:**

- \*1 Refer to Figure 1.
- \*2 For cases where conformance to various safety standards (UL, EN etc.) is required, to be described as 100-240Vac (50/60Hz).
- \*3 At 115/230Vac, 25°C ambient temperature.
- \*4 Not applicable for the noise filter inrush current less than 0.2mS.
- \*5 From 85~132Vac or 170~265Vac, constant load.
- \*6 From No-load to Rated load, constant input voltage. Measured at the sensing point in Remote sense.
- \*7 Measured with JEITA-RC9131A 1:1 probe with 2x270uF electrolytic capacitors and 1uF film capacitor on the output, 20MHz B.W. When Power Supplies are installed in HFE1600-S1U shelf, measured with 1uF film capacitor on the output terminals of the HFE1600-S1U.
- \*8 Voltage drop on load wires: HFE1600-12: 0.25V/wire; HFE1600-24: 0.5V/wire; HFE1600-32: 0.75V/wire; HFE1600-48: 1V/wire.
- \*9 Accuracy applicable for load current > 50% of rated output current. Derate maximum output power by 5%.
- \*10 Inverter shut down method. Reset by AC voltage recycle or by On/Off control.
- \*11 Measured with JEITA-RC9131A 1:1 probe with 470uF electrolytic capacitor and 0.1uF film capacitor on the output, 20MHz B.W. Capacitors are not required when the Power Supply is installed in HFE1600-S1U shelf.
- \*12 Measured according to UL, EN method at 60Hz, 25°C ambient temperature.
- \*13 Open collector signal. Maximum sink current: 10mA, maximum voltage 15V.
- \*14 HFE1600 series considered as professional equipment and not intended for sale to general public.
- \*15 Refer to Output Power vs. temp derating figure A, B, C (Paragraph 1.2).

### 1.1 HFE1600 rated output Current and Voltage versus Line Voltage.

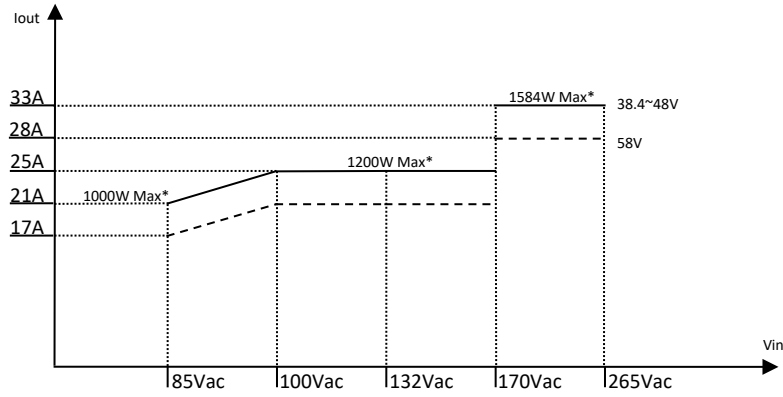

Figure 1-1: HFE1600-48

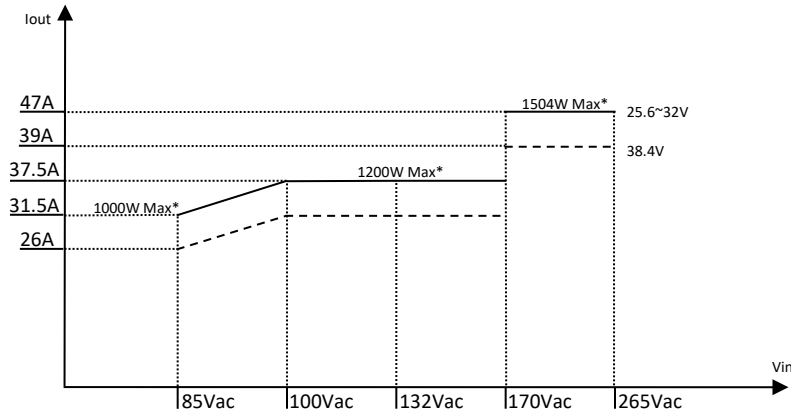

Figure 1-2: HFE1600-32

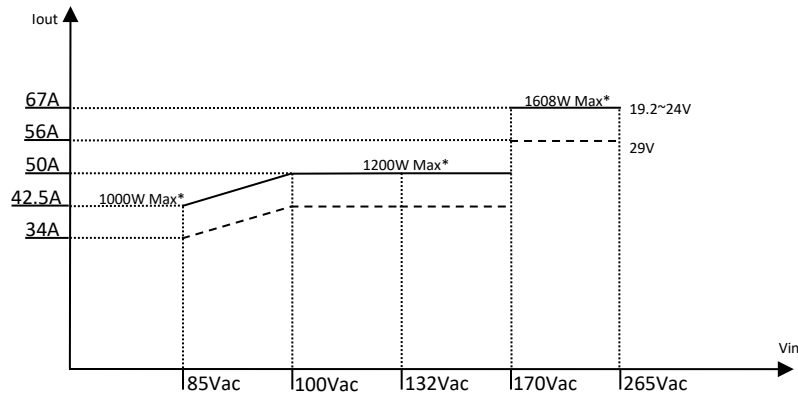

Figure 1-3: HFE1600-24

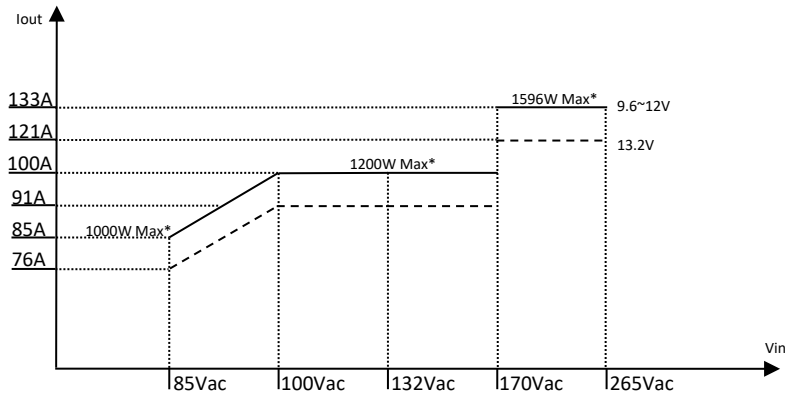

Figure 1-4: HFE1600-12

## 1.2 HFE1600 Output Power vs. Temp derating.

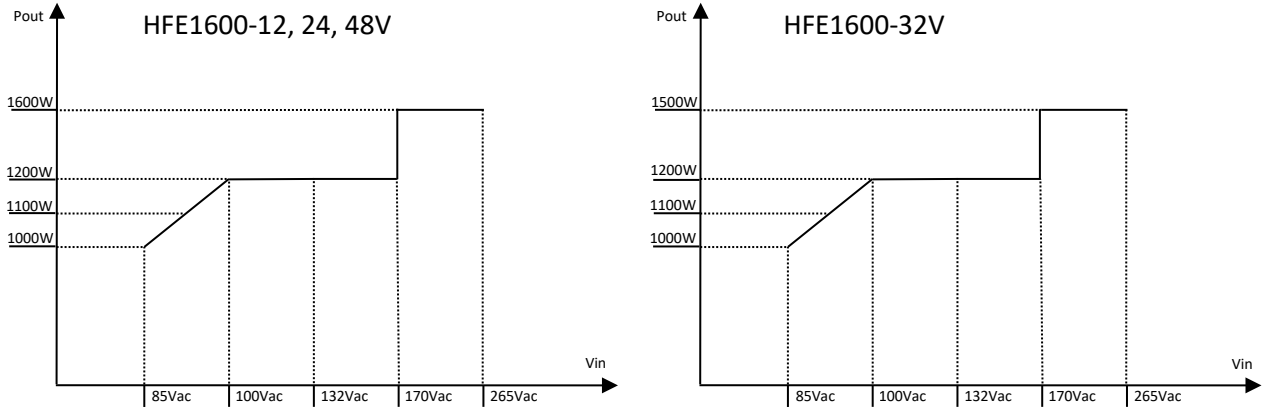

Figure 1-5: Output Power at temp -10~50°C.

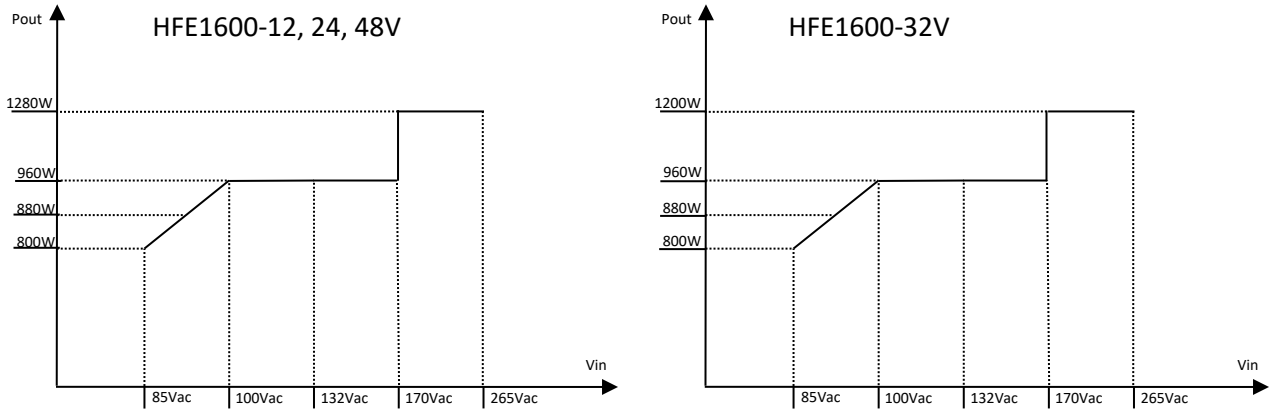

Figure 1-6: Output Power derating at temp 60°C.

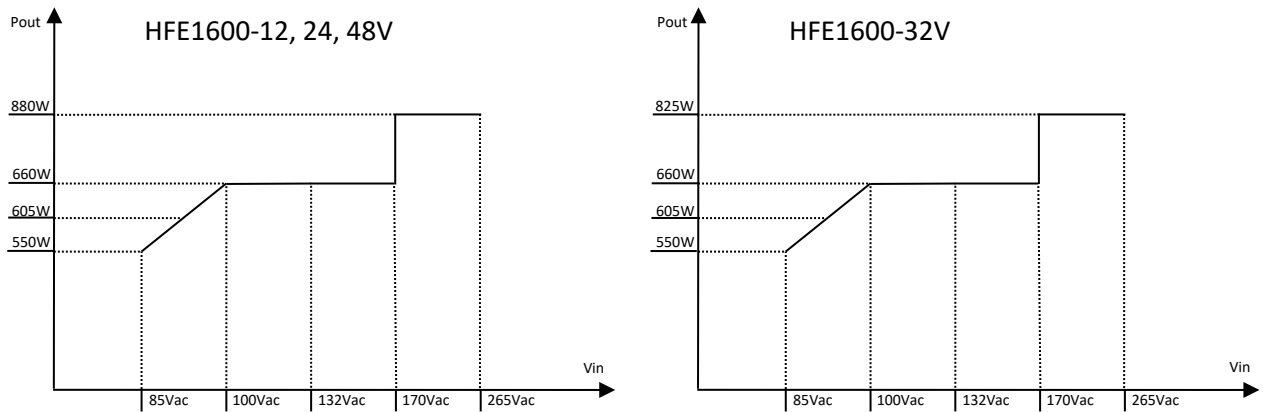
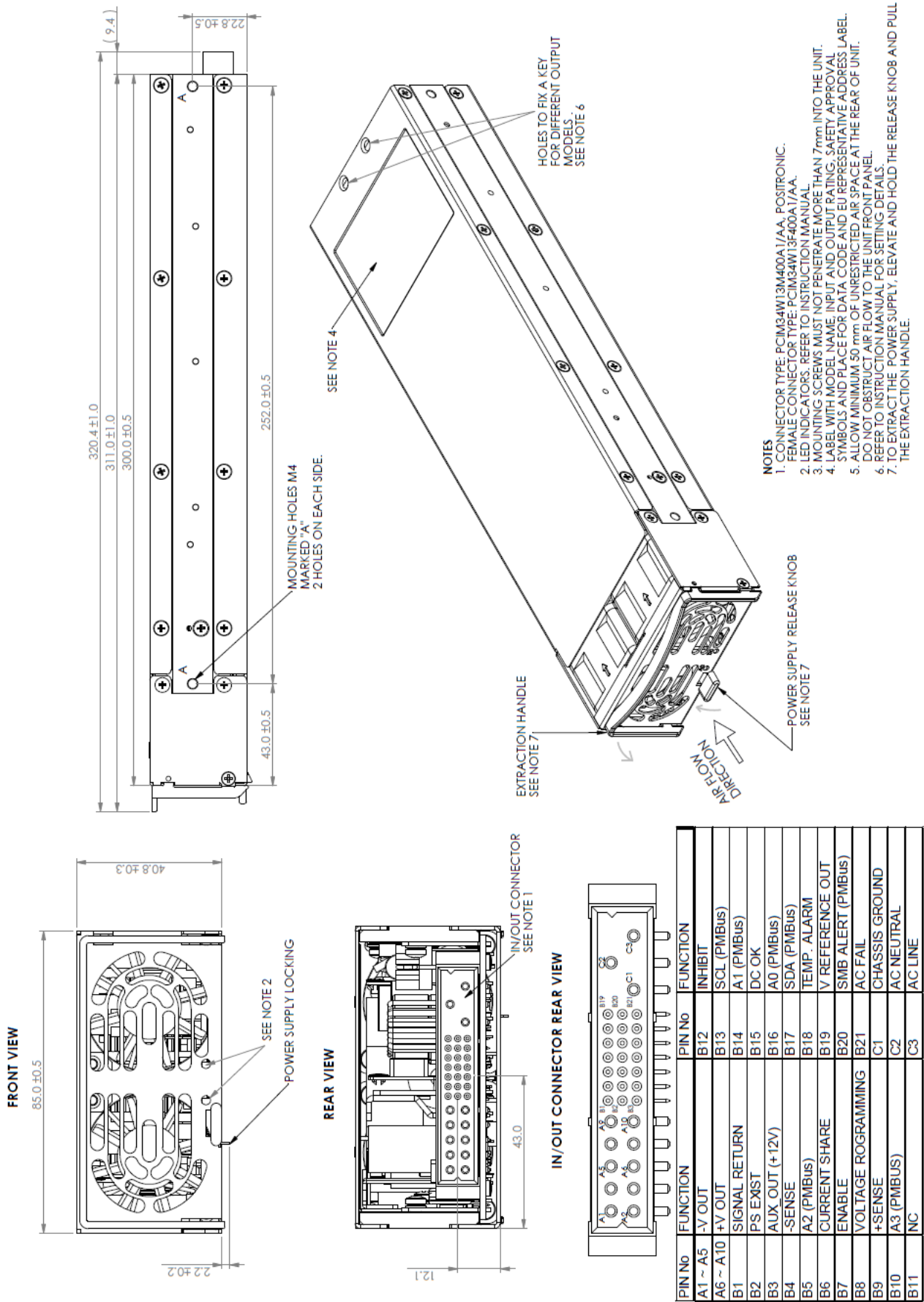

Figure 1-7: Output Power derating at temp 70°C.

### 1.3 HFE1600 Outline Drawing



## 1.4 Rear Panel IN/OUT Connector Pins Function Description

Pin #	Function	Description	Referenced to
A1~A5	-V	Main Negative Output Voltage.	
A6~A10	+V	Main Positive Output Voltage.	
B1	SIGNAL RETURN	Return for the following control signals: ENABLE, INHIBIT; Supervisory signals: TEMP ALARM, AC FAIL, AUX, DC OK and PS EXIST. PMBus signals: SCL, SDA and SMB ALERT. SIGNAL RETURN and mentioned signals are isolated from the output terminals and -SENSE.	
B2	PS EXIST	Indicates that Power Supply module is inserted into the shelf. "Active Low".	SIGNAL RETURN
B3	+12V AUX OUT	11.2 ~ 12.5V Auxiliary Voltage Output. Maximum load current is 0.5A. This output has a built in O-Ring diode. Not affected by the INHIBIT/ENABLE signal or any other fault.	SIGNAL RETURN
B4	-SENSE	Negative sense. The -SENSE signal should be connected to -V on Power Supply or Load side.	-SENSE
B5	NOT CONNECTED		-SENSE
B6	CURRENT SHARE	Current sharing signal should be connected when Power Supplies are connected in parallel, to allow accurate current share between units.	-SENSE
B7 (short pin)	ENABLE	Turns ON the main output by electrical signal or dry contact. ON: 0~0.6v or short; OFF: open.	SIGNAL RETURN
B8	VOLTAGE PROGRAMMING	Input 0~5V. Provides Vout programming by Voltage. Refer to Section 3.2.5 and Section 3.2.6.	-SENSE
B9	+SENSE	Positive sense. The +SENSE signal should be connected to +V on Power Supply or Load side.	+SENSE
B10, B11	NOT CONNECTED		
B12	INHIBIT	Turns OFF the main output by electrical signal or dry contact. OFF: 0~0.6v or short; ON: open. Requires the "ENABLE" signal to be connected to "Signal Return"	SIGNAL RETURN
B13, B14	NOT CONNECTED		SIGNAL RETURN
B15	DC OK	DC OK signal. LOW when the output voltage is higher than 90% ± 5% of set Vout. Open collector type (15V, 10mA).	SIGNAL RETURN
B16, B17	NOT CONNECTED		SIGNAL RETURN
B18	TEMPERATURE ALARM	TEMP ALARM signal. LOW when the internal temperature is within safe limit; HIGH approx. 10°C below Thermal shut down. Open collector type (15V, 10mA).	SIGNAL RETURN
B19	+5V	5V fix output voltage	-SENSE
B20	NOT CONNECTED		SIGNAL RETURN
B21	AC FAIL	AC FAIL Signal; LOW when the input voltage is 85Vac<Vin<270Vac; HIGH when the input voltage is 85Vac>Vin or Vin>270Vac. Open collector type (15V, 10mA).	SIGNAL RETURN
C1 (long pin)	PROTECTIVE GROUND	AC GROUND. Refer to Section 2.1 for Safety Instructions.	
C2 (long pin)	AC NEUTRAL	AC NEUTRAL. Refer to Section 2.1 for Safety Instructions.	
C3 (long pin)	AC LINE	AC LINE. Refer to Section 2.1 for Safety Instructions.	

Table 1-1: Rear panel IN/OUT pins

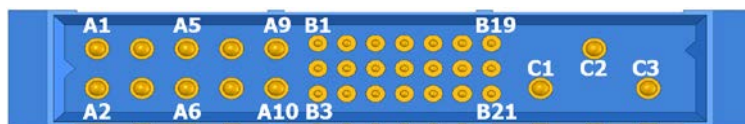

Figure 1-8: IN/OUTPUT CONNECTOR POSITRONIC P/N: PCIM34W13M400A1/AA

## CHAPTER 2: SAFETY APPROVALS

UL 60950-1 and CSA22.2 No.60950-1 - UL Recognized. C-UL for Canada.

IEC 60950-1 - CB Report and Certificate.

EN 60950-1 - CE mark.

Marking by the CE Symbol indicates compliance to the Low Voltage Directive of the European Union.

A "Declaration of Conformity" in accordance with the preceding directives and standards has been made and available on file at our EU representative TDK LAMBDA GERMANY GmbH, located at Karl-Bold-Str. 40, D-77855 Achern.

A "Declaration of Conformity" may be accessed via company website [www.emea.tdk-lambda.com/manual](http://www.emea.tdk-lambda.com/manual).

### 2.1 Safety Instructions

**CAUTION:** The following safety precaution must be observed during all phases of operation, service and repair of this equipment. Failure to comply with the safety precautions or warnings in this document violates safety standards of design, manufacture and intended use of this equipment and may impair the built-in protections within. TDK Lambda shall not be liable for user's failure to comply with these requirements.

#### Vorsicht

Die folgenden Sicherheitsvorschriften müssen vor Inbetriebnahme und in jedem Betriebszustand bei Service oder Reparatur beachtet werden. Missachtung der Sicherheitsvorschriften und Warnhinweise aus diesem Handbuch führen zur Verletzung der bestehenden Sicherheitsstandards. Bei Betrieb des Gerätes ausserhalb dem bestimmungsgemässen Einsatz können die im Gerät integrierten Schutzfunktionen beeinträchtigt werden.

TDK-Lambda ist nicht haftbar für Schäden, die durch Missachtung dieser Sicherheitsvorschriften entstehen können.

**CAUTION:** HFE1600-xy units are not authorized for use as critical component in nuclear control systems, life support systems or equipment for use in hazardous environments without the express written approval of the managing director of TDK-Lambda.

#### Vorsicht

Dieses Produkt ist nicht für die Verwendung als kritische Komponente in nuklearen Steuerungssystemen, lebenserhaltenden Systemen oder Geräte für den Einsatz in gefährlichen Umgebungen, ohne die ausdrückliche schriftliche Genehmigung durch TDK-Lambda zugelassen.

### POWER SYSTEM, OVERVOLTAGE CATEGORY & ENVIRONMENTAL CONDITIONS

The HFE1600-xy units have been evaluated for using in TT and IT (230VAC line - to - line) power systems.

The HFE1600-xy units have been evaluated to Overvoltage category II.

The HFE1600-xy units intended for use in the following operation conditions:

\* Indoor use                      \* Pollution degree 2                      \* Max. Operational altitude: 3000m above sea level

\* Ambient temperature: -10°C-50°C at 100% load, up to 70°C with output de-rating applied (refer to Specification above).

### GROUNDING

HFE1600-xy units are Class I product. To minimize electrical shock hazard, the HFE1600-xy units must be connected to an electrical ground. The instruments must be connected to the AC power supply mains through a three conductor power cable, with the ground wire firmly connected to an electrical ground (safety ground) at the power outlet. For instruments designed to be hard-wired to the supply mains, the protective earth terminal must be connected to the safety electrical ground before any other connection is made. Any interruption of the protective ground conductor or disconnection of the protective earth terminal will cause a potential shock hazard that might cause personal injury.

#### Erdungskonzept

Dieses Produkt ist ein Gerät der Schutzklasse 1. Zur Vermeidung von gefährlichen Energieinhalten und Spannungen, ist das Gehäuse an eine Schutzterde anzuschliessen. Der PE-Anschluss ist an einen festen Erder anzuschliessen. Bei Festverdrahtung des Gerätes ist sicherzustellen, dass der PE Anschluss als erstes angeklemt wird. Jede mögliche Unterbrechung des PE-Leiters oder Trennung der PE Verbindung kann einen möglichen elektrischen Schlag hervorrufen, der Personenschäden zur Folge hätte.

### LIVE CIRCUITS

Operating personnel must not remove the HFE1600-xy unit cover.

No internal adjustment or component replacement is allowed by non-TDK Lambda qualified service personnel. Never replace components with power cable connected. To avoid injuries, always disconnect power, discharge circuits and remove external voltage sources before touching components.

Restricted Access Area: HFE1600-xy units should only be installed in a Restricted Access Area. Access should be available to service personnel only.



**Spannungsführende Teile**

Die Geräteabdeckung darf nicht durch Endanwender geöffnet werden. Interne Modifikationen, sowie Bauteilaustausch ist nur durch TDK-Lambda qualifiziertes Personal erlaubt. Vor Austausch von Bauteilen ist das Netzkabel bzw. die Versorgungsspannung zu trennen. Energieversorgungsanschlüsse sind immer zu trennen, um Personenschäden durch gefährliche Energieinhalte und Spannungen auszuschließen. Die Stromkreise sind zu entladen, externe Spannungsquellen sind zu entfernen, bevor auf Bauteile bzw. Komponenten Ebene gearbeitet wird.

**PARTS SUBSTITUTIONS & MODIFICATIONS**

Parts substitutions and modifications are allowed to authorized TDK Lambda service personnel only. For repairs or modifications, the instrument must be returned to TDK Lambda service facility.

**AC INPUT**

Do not connect HFE1600-xv unit to mains supply exceeding the input voltage and frequency rating. The input voltage and frequency rating is: 100-240V~, 50/60Hz. For safety reasons, the mains supply voltage fluctuations should not exceed ±10% of nominal voltage.

**HEAT HAZARD**

WARNING: Top, bottom and side surfaces may become hot when operating the unit continuously. To reduce the risk of injury from a hot surface, allow the surface to cool before touching.

**Heisse Oberflächen**

WARNUNG: Im Dauerbetrieb erwärmen sich die Gehäuseoberflächen. Um das Verletzungs-Risiko durch heisse Oberflächen zu minimieren, sollte das Gerät einige Zeit abkühlen können, bevor weitere Arbeiten durchgeführt werden.

**ENERGY HAZARD**

The main output of HFE1600-xy units is capable of providing hazardous energy. Due to hazardous energy level the output and connections therefore must not be user accessible. Manufacturer’s final equipment must provide protection to service personnel against inadvertent contact with output bus bars.

**FUSE**

Internal fuse is sized for fault protection and if a fuse was opened it would indicate that service is required. Fuse replacement should be made by qualified technical personnel. HFE1600-xy unit fuse rating is described below. F101: F20A H 250Vac.

**SICHERUNGEN**

Vor Anschluss an die Netzversorgung ist die Aufstellanleitung zu beachten!

1. Absicherung: F1 01: F20A H 250VAC
2. Die Gehäuseabdeckung darf nur im stromlosen Zustand geöffnet werden.

**ACHTUNG:** Sicherungen dürfen nur durch geschulte Service Personen getauscht werden.









**OVERCURRENT PROTECTION:**

A readily accessible branch circuit over-current protective device rated 30A max. Must be incorporated in the building wiring. The protective device must be disconnect both supply line simultaneously.

**Überstromschutz**

Eine leicht zugängliche Vorsicherung mit 30A max.. pro Eingang muss in der Hausinstallation vorgesehen werden

**SYMBOLS/ ZEICHEN:**

	<p>Caution, risk of danger. Instruction manual symbol. The instrument will be marked with this symbol when it is necessary for the user to refer to the Safety &amp; Installation or Instruction manual.</p> <p>Achtung Gefahr. Symbol im Benutzerhandbuch. Das Gerät wird mit diesem Symbol gekennzeichnet, wenn der Benutzer auf das Sicherheits- &amp; Installationshandbuch oder die Bedienungsanleitung verwiesen wird.</p>
	<p>Indicates ground terminal.</p> <p>Zeigt einen Erdungsanschluss an.</p>
	<p>Protective Ground Conductor Terminal.</p> <p>Schutzleiterklemme.</p>
	<p>CAUTION Live component danger due to electric shock or energy content.</p> <p>VORSICHT Spannungsführende Teile-Gefahr durch elektrischen Schlag bzw. Energieinhalte.</p>
	<p>Indicates the presence of a hot surface or component. Touch of a hot surface can cause injury.</p> <p>Dieses Symbol weist auf das Vorhandensein einer heißen Oberfläche oder Komponente. Das Berühren dieser Oberfläche kann zu Verletzungen führen.</p>
	<p>Direct current (DC).</p> <p>Gleichstrom (DC).</p>
	<p>Alternate current (AC).</p> <p>Wechselstrom (AC).</p>
	<p>Denotes hazard. A procedure requires specific attention. Not following the procedure correctly could result in a personal injury. A WARNING sign should not be skipped and all indicated conditions must be fully understood and met.</p> <p>Weist auf Gefahren hin, die eine besondere Aufmerksamkeit erfordern. Eine Nichteinhaltung dieser Vorgehensweise, kann zu Körperverletzungen führen. Ein WARN-Hinweis sollte nicht übergangen und alle angeführten Bedingungen müssen eindeutig verstanden und umgesetzt werden.</p>
	<p>Denotes hazard. A procedure requires specific attention. Not following the procedure correctly could result in damage to the equipment. Do not proceed beyond a CAUTION sign until all indicated conditions are fully understood and met.</p> <p>Weist auf Gefahren hin, die eine besondere Aufmerksamkeit erfordern. Wenn die beschriebene Vorgehensweise nicht korrekt durchgeführt wird, kann dadurch das Gerät beschädigt werden. Führen Sie einem VORSICHTS-Hinweis erst durch, wenn Sie alle angezeigten Handlungen eindeutig verstanden und umgesetzt haben.</p>

## CHAPTER 3: SINGLE UNIT OPERATION

### 3.1 Front Panel Indicators

#### 1. DC OK – LED indicator:

GREEN Output Voltage is above  $90\% \pm 5\%$  of set Output Voltage.

RED Output Voltage is below  $90\% \pm 5\%$  of set Output Voltage.

#### 2. AC OK – LED indicator:

GREEN Input Voltage ( $V_{in}$ ) is in the range of 85Vac to 270Vac.

OFF Input Voltage ( $V_{in}$ ) is below 85Vac or above 270Vac.

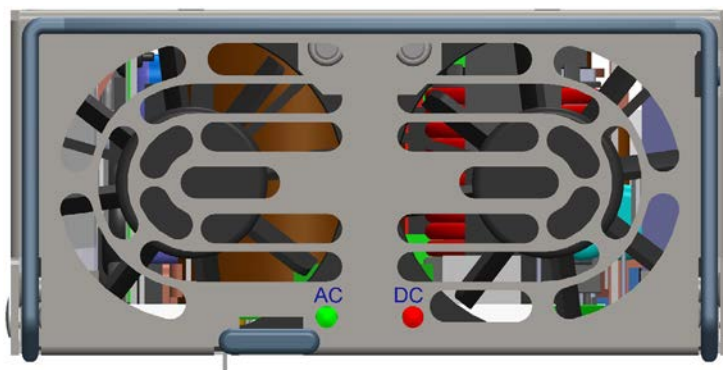

Figure 3–1: Front Panel Indicators

#### CAUTION:

When inserting a power supply into the rack, do not use unnecessary force; Slamming the power supply into the rack can damage the connectors on the rear of the supply and inside the rack.

#### ATTENTION:

Power supplies are factory programmed to the rated output voltage. For applications requiring lower / higher voltage, power supplies should be adjusted to the required voltage before connection to the load.

## 3.2 Single unit operation

### 3.2.1 Basic configuration (Local Sense)

- $\pm$  SENSE have to be connected to the HFE1600  $\pm$ V terminals prior to operating the supply.
- ENABLE input must be connected to SIGNAL RETURN in order for the supply to turn on.

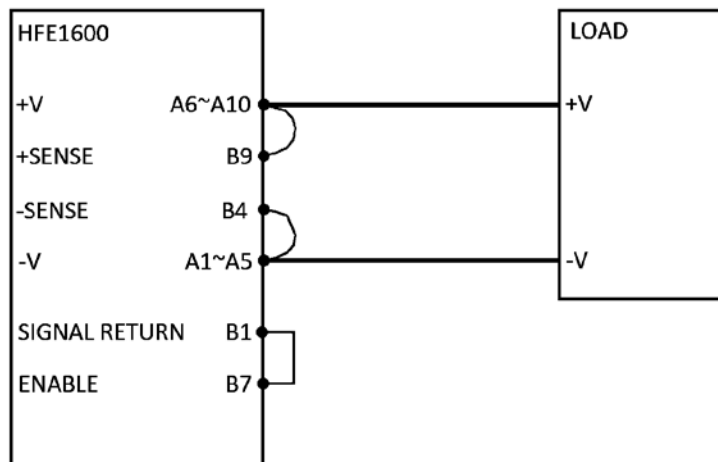

**Figure 3-2: Local Sense Connection**

### 3.2.2 Basic configuration (Remote Sense)

- $\pm$  SENSE have to be connected to the  $\pm$ V terminals on the Load side prior to operating the supply.
- ENABLE input must be connected to SIGNAL RETURN in order for the supply to turn on.

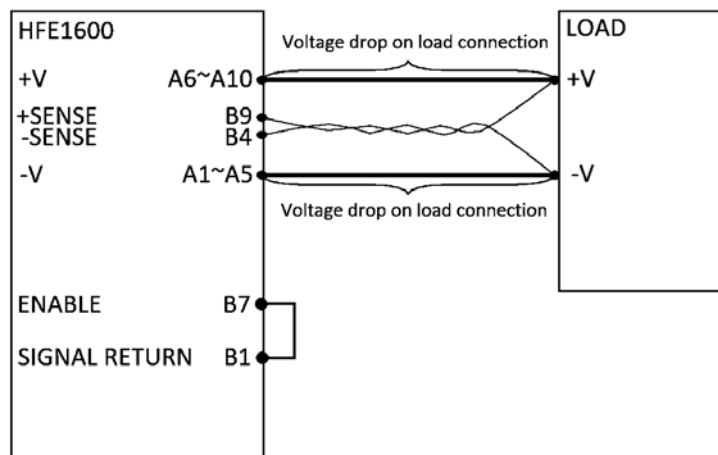

**Figure 3-3: Remote Sense Connection**

**ATTENTION:**

1. Maximum voltage drop on load connection:  
HFE1600-12: 0.25V/wire; HFE1600-24: 0.5V/wire; HFE1600-32: 0.75V/wire; HFE1600-48: 1V/wire.
2. Twisted wires should be used for Remote Sensing connection.
3. If Remote Sensing is used, do not break Main Output connection.

### 3.2.3 ON/OFF Control by Enable

SIGNAL RETURN and ENABLE control are isolated from the output terminals and "-SENSE".

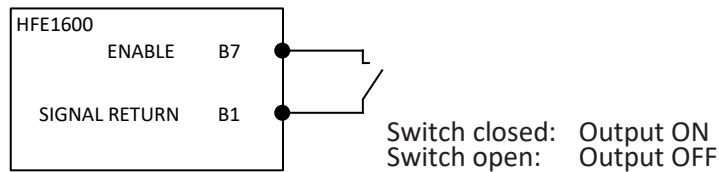

Figure 3-4: Control by ENABLE

### 3.2.4 ON/OFF Control by INHIBIT

Power Supply operation requires the "ENABLE" signal to be connected to "Signal Return".

Logic of the "INHIBIT" signal is reversed to logic of the "ENABLE" signal.

SIGNAL RETURN, INHIBIT and ENABLE controls are isolated from the output terminals and -SENSE.

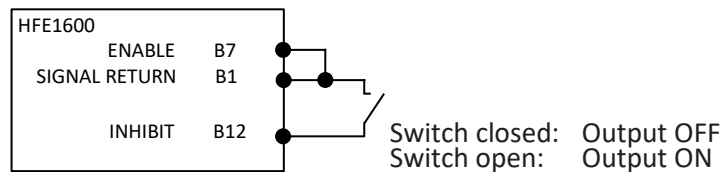

Figure 3-5: Control by INHIBIT

### 3.2.5 Output Voltage Programming by External Voltage

Output Voltage of HFE1600 Series can be programmed by external voltage source between approximately 80%-120% for 24V, 32V, 48V and 80%-110% for 12V of nominal output voltage

(For Output voltage limits see Graph enclosed).

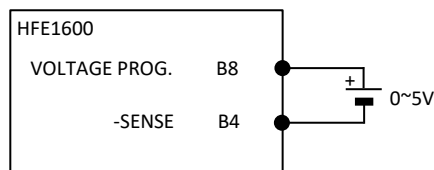

Figure 3-6: Control by Ex. Voltage

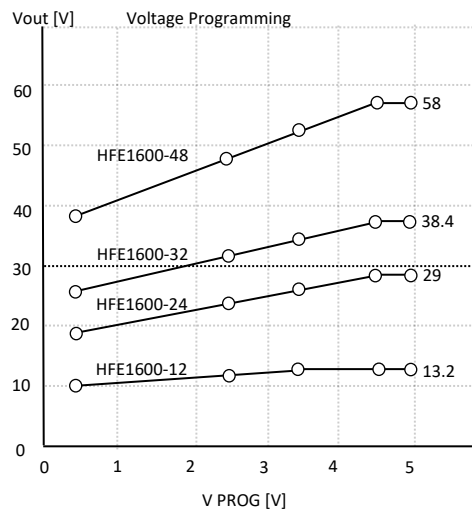

Figure 3-7: Output Voltage Limits

### 3.2.6 Output Voltage Programming by External Potentiometer

Output Voltage of HFE1600 Series can be trimmed by potentiometer between approximately 80%-120% for 24V, 32V, 48V and 80%-110% for 12V of nominal output voltage (For Output voltage limits see Graph below).

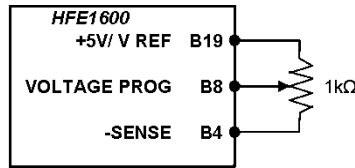

Figure 3–8: Control by Ex. Potentiometer

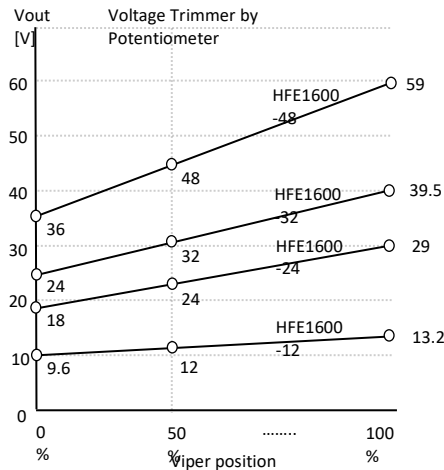

Figure 3–9: Output Voltage Limits

### 3.2.7 SUPERVISORY Signals (Typical Connection)

The following supervisory signals are accessible:

- DC OK
- AC FAIL
- PS EXIST
- TEMP ALARM

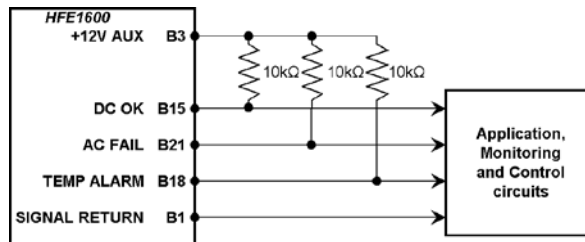

Figure 3–10: Signals

**SIGNAL RETURN** and mentioned signals are isolated from the output terminals and **-SENSE**.

These signals are Open Collector type (max 15V, max 10mA) shunted by internal 24V Zener, isolated from Output and referenced to "SIGNAL RETURN".

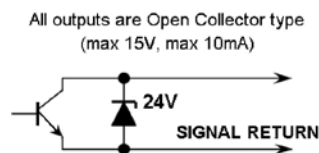
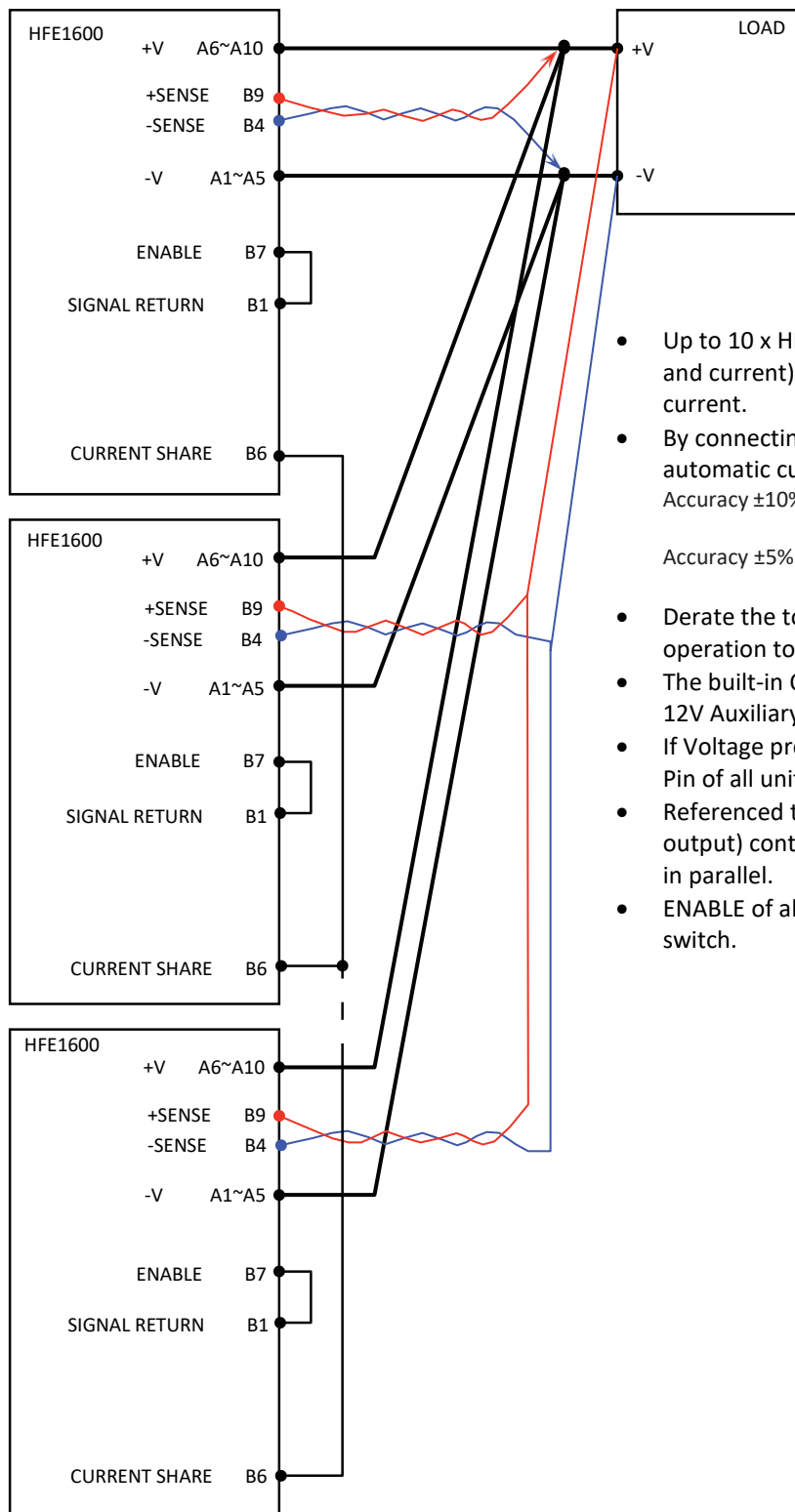

Figure 3–11: Open collector signals are shunted by internal 24V Zener

## CHAPTER 4: POWER SUPPLIES CONNECTION

### 4.1 Parallel Operation



- Up to 10 x HFE1600 units with the same rating (voltage and current) can be used in parallel to increase the output current.
- By connecting the CS signal between the paralleled units, automatic current balance is achieved with accuracy of
 

Accuracy $\pm 10\%$ :	$20\% \leq I_{out} < 50\%$ of max Iout.
	Up to 10 units
Accuracy $\pm 5\%$ :	$I_{out} \geq 50\%$ of max Iout.
	Up to 10 units.
- Derate the total output current by 5% when using parallel operation to prevent unit overload condition.
- The built-in O-Ring MOSFETs on the main output and the 12V Auxiliary output allow N+1 operation.
- If Voltage programming is used, "Voltage Programming" Pin of all units must be connected in parallel.
- Referenced to "SIGNAL RETURN" (floating from the output) controls/signals and +12V AUX can be connected in parallel.
- ENABLE of all supplies can be connected to a single switch.

Figure 4–1: Parallel Connection

## 4.2 Series Operation

- Up to 2 units with the same rating (voltage and current) can be used in series to increase the output voltage.
- Connect Main Output in series (as shown).
- Diodes should be connected in parallel with each unit output to prevent reverse voltage. Each diode should be rated to at least the power supply rated output voltage and output current.
- Connect as shown: +Sense of positive unit and –Sense of negative unit (twisted pair) to Load point, or to +V and –V accordingly for Local Sense.
- Output Voltage can be adjusted independently for each unit.
- Controls Monitoring signals and +12V AUX are referenced to “SIGNAL RETURN” and may be connected in parallel.

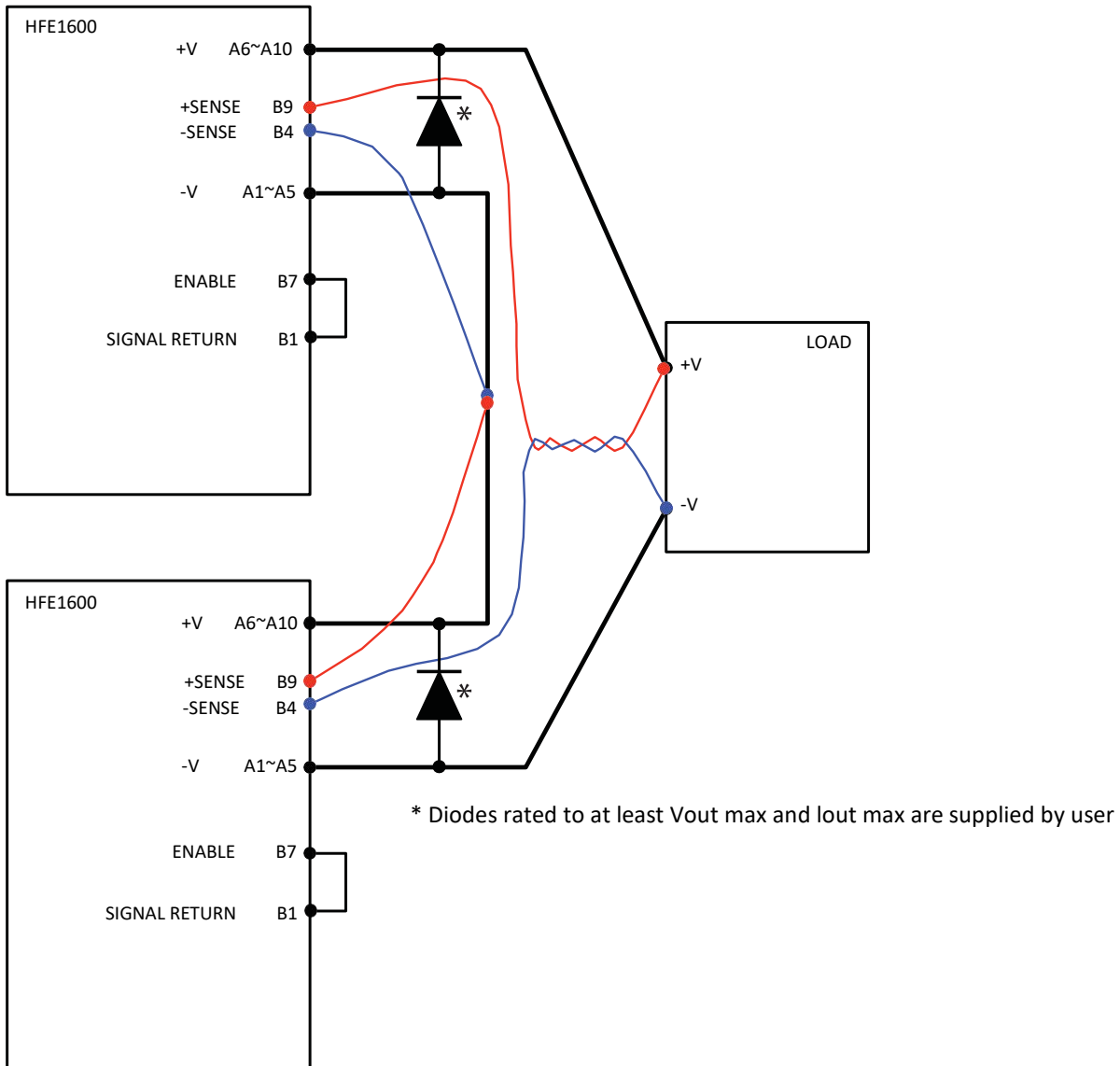

Figure 4–2: Series Connection (Remote Sense Configuration)